

BA688C

Panel mounting Serial text display

Issue: 3

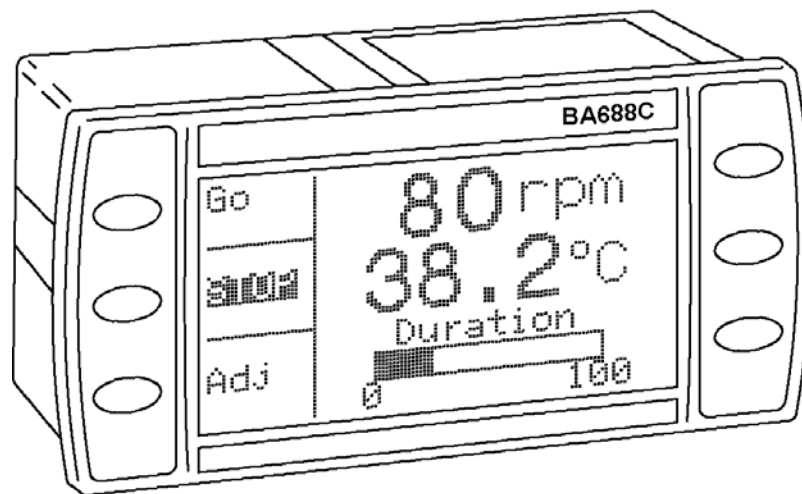

CONTENTS

1. Description

- 1.1 Documentation
- 1.2 Version 3.4 firmware

2. Operation

3. Applications

- 3.1 Legacy protocol
- 3.2 Modbus protocol
- 3.3 BEKA protocol

4. System Design

- 4.1 Power supply
- 4.2 Communications
- 4.3 Switch outputs
- 4.4 External switches

5. Installation

- 5.1 Location
- 5.2 Installation procedure
- 5.3 EMC

6. Configuration

- 6.1 Default configuration
- 6.2 Accessing the configuration menus
- 6.3 Summary of configurable functions
- 6.4 Quick access menu

7. Maintenance

- 7.1 Fault finding during commissioning
- 7.2 Fault finding after commissioning
- 7.3 Servicing
- 7.4 Routine maintenance
- 7.5 Guarantee
- 7.6 Customer comments

8. Accessories

- 8.1 Tag number
- 8.2 Serial Text Display - Programming Guide.
- 8.3 Serial Text Display – Modbus Interface Guide.

9. Index

Appendix 1

Getting Started Quickly

1. DESCRIPTION

The BA688C is a 24V dc powered instrument which can display text and simple graphics in a process area. Incorporating a backlit 120 x 64 pixel graphical display, six operator push-buttons and two single pole switch outputs, it is a versatile operator interface for simple machine or process control applications.

Housed in a robust 72 x 144 panel mounting DIN enclosure, the BA688C text display has an IP66 front panel and is supplied with a gasket to seal the joint between the instrument and the panel.

The BA688C is available with an RS232 or with an RS485 communication port.

1.1 Documentation

This instruction manual describes system design, conditioning and installation of the BA688C serial text display. If you wish to quickly install and commission a BA688C for a basic application, please start by reading Appendix 1 of this manual, Getting Started Quickly

For detailed programming information separate guides describe the Modbus RTU and BEKA protocols. These are available from our sales department or may be downloaded from www.beka.co.uk

Serial Text Display–Modbus Interface Guide

Description of parameters
Use of standard screens

Serial Text Display–Programming Guide

BEKA protocol
Command summary & reference
Custom screens
Scripting
Pattern matching
Advance functions

1.2 Version 3.4 Firmware

This manual describes the additional features available in text displays employing version 3.4 firmware which was released in October 2009. Namely:

Two eight variable standard screens added.

Integer variables added to the Modbus register map to complement the original float values.

New function allows the number of process variables to be entered, so that when scrolling the display unused screens are not shown.

Enhancements to to the Scripting facility.

The instrument's firmware version can be established using the 'Unit Info' function in the main configuration menu - see section 6.3 of this manual. Text displays employing Version 3.4 firmware are backwards compatible with all earlier versions.

2. OPERATION

Fig 1 shows a simplified block diagram of a BA688C serial text display. Two versions are available, one has an RS232 port and the other an RS485 port. The type of port is shown on the label adjacent to rear terminals 3, 4 and 5. The two switch outputs may be controlled and the operator push-buttons interrogated via the serial communication link.

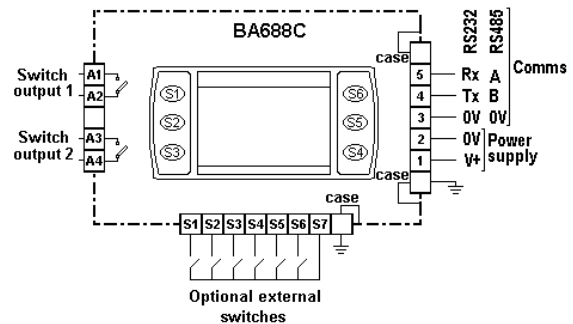

Fig 1 Simplified block diagram of BA688C

3. APPLICATIONS

The BA688C has been designed for easy integration with most serial data sources and therefore contains a wealth of features. Although at first sight the complexity may seem daunting, the support documentation is application related so that only relevant sections need to be read. If additional help is needed BEKA engineers are always willing to assist with system design, programming and screen development.

The BA688C may be used with three alternative protocols; Legacy, BEKA or Modbus. The pattern matching function also enables proprietary ASCII serial data, such as that from a weighing system, to be decoded and displayed. This advanced feature is described in the *Serial Text Display – Programming Guide*.

3.1 Legacy protocol

The Legacy protocol contained in the BA688C allows the instrument to replace an MTL644 IS text display for safe area (non hazardous) applications.

The MTL644 uses proprietary two wire communications generated by an MTL5051 galvanic isolator from an RS232 or RS422 safe area port. A BA688C can therefore replace an MTL644 display for a safe area application and eliminate the need for an MTL5051 isolator. The BA688C replicates all the functions of an MTL644 and has the advantage of a backlit display.

WARNING

The BA688C serial text display is not intrinsically safe and must not be installed in a hazardous area.

Legacy protocol only allows three external switches S1, S2 & S3, not the front panel push-buttons, to be used for operator inputs. Similarly, the MTL644 only has one output control, so the two BA688C switch outputs operate in parallel.

When using Legacy protocol, the configuration menus are only operational between power being applied to the BA688C and the first message being received.

3.2 Modbus protocol

Using the Modbus protocol, up to eight process variables, together with their units of measurement and tag description may be displayed on one of the nine standard screen formats shown below. These illustrate typical units of measurement and tag information, but any may be entered. This allows one, two or four process variables to be shown on a common screen without the need for any programming, apart from setting the BA688C address and writing each Modbus variable in the required Modbus register address map.

If more process variables than can be shown on the selected standard screen are to be displayed, the operator can select which process variables are shown by operating the *Up* or *Down* push-buttons. This selection can also be made by the system host.



One variable

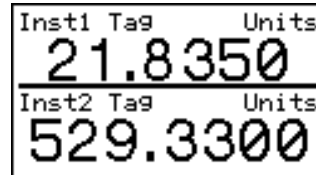

Two variables

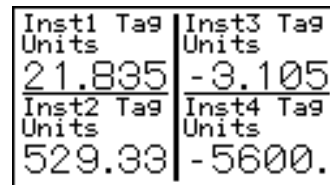

Four variables

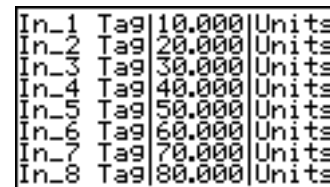

Eight variables

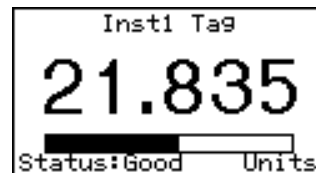

One variable + horizontal bargraph

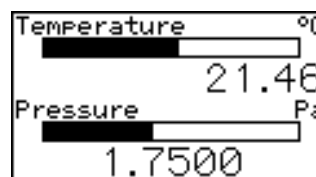

Two variables + horizontal bargraphs

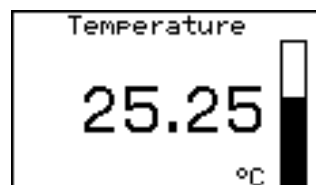

One variable + vertical bargraph

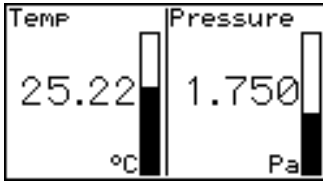

Two variables + vertical bargraphs

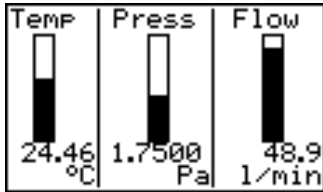

Three variables + vertical bargraphs

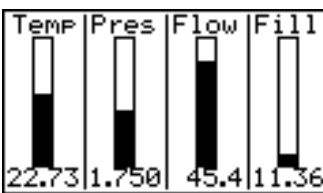

Four variables + vertical bargraphs



Eight variables + horizontal bargraphs

3.3 BEKA protocol

BEKA protocol enables text to be written anywhere on the screen in five different font sizes, together with lines, boxes and bargraphs. Alternatively one of the nine standard display screens described in section 3.2 may be used.

Simple bit map graphics may also be downloaded to the display and all characters can be reversed or flashed. Information may also be written to a hidden screen that may be displayed when required.

This protocol enables each of the six front panel push-buttons to be interrogated so they may be used for operator controls. By displaying the switch function on the screen adjacent to the button, 'soft switches' can be created. If larger industrial size push-buttons are required, these may be connected to the BA688C terminals. When external switches are used the front panel switches are disabled.

The two single pole outputs may be independently controlled for switching any small load such as a sounder, beacon or valve.

BEKA protocol is described in the *Serial Text Display – Programming Guide* which is available from the BEKA sales office and from the BEKA web site.

The Modbus protocol also enables each of the six front panel push-buttons to be interrogated so they may be used for operator controls. If larger industrial size push-buttons are required, these may be connected to the BA688C terminals. When external switches are used the instrument front panel switches are disabled.

The two single pole outputs may be independently controlled for switching low power loads such as sounders, beacons and valves.

Modbus protocol is described in the *Serial Text Display – Modbus Guide*, which is available from the BEKA sales office and from the BEKA web site.

For more demanding applications BEKA protocol may be used to construct custom display screens for use in a Modbus system. See *Serial Text Display – Programming Guide*, which is available from the BEKA sales office and from the BEKA web site.

4. SYSTEM DESIGN

Figure 1 shows a functional block diagram of BA688C serial text display. Terminal locations are shown in Fig 4.

4.1 Power supply

Any dc power supply having an output between 20 and 36 volts that is capable of supplying 95mA may be used to power the BA688C. The power supply output ripple must not cause the instantaneous voltage to fall below 20V.

The BA688C does not have galvanic isolation between the power supply, external switch and serial communication terminals. If a common or earthed supply is used, the communication port and the optional external switches should only be connected to electrically isolated circuits.

4.2 Communication

The BA688C serial text display is available with either an RS232 or an RS485 communication port. This is a factory set option that can not be changed on site. The type of port is shown on a label adjacent to the port terminals.

Fig 2 shows connections for both types of port.

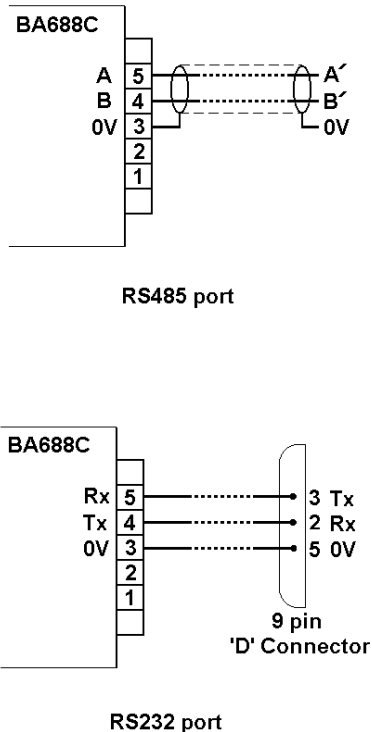

Fig 2 RS485 & RS232 port connections

4.3 Switch outputs

The BA688C serial text display has two single pole relay outputs which may be used for switching small loads such as valves, actuators and sounders.

The output relay contact rating must not be exceeded.

| | | |
|------|----|---------|
| 240V | 5A | 1.25kVA |
| 30V | 5A | 150W dc |

When a reactive load is being switched by the relay contact, it is essential that a suppresser is fitted to prevent contact damage and radio frequency interference. A 0.1 μ F capacitor in series with a 100 Ω resistor connected between the relay contacts will usually provide adequate suppression. Proprietary encapsulated suppression assemblies can be purchased from electrical suppliers. Please note that BEKA associates' guarantee excludes relay contact damage.

WARNING

These switch outputs should not be used for critical safety applications.

When the BA688C power supply is turned off or disconnected, both switch outputs will open.

4.4 External switches

For applications requiring operator inputs to be made by large industrial push-buttons, terminals S1 to S7 allow six external switches to be connected to the text display. When the external push-buttons are enabled in the configuration menu, the front panel push-buttons are automatically disabled for operator inputs, although they continue to function for instrument configuration.

The external switch terminals are not isolated from the BA688C power supply and communication terminals. External switches should therefore be floating, i.e. not earthed or connected to any other circuits.

5. INSTALLATION

5.1 Location

The BA688C is housed in a robust aluminium enclosure with a toughened glass window mounted in a Noryl bezel. The front of the instrument provides IP66 protection and a gasket seals the joint between the instrument enclosure and the panel. The instrument may be installed in any panel providing the environmental limits shown in the specification are not exceeded.

Fig 3 shows the overall dimensions of the BA688C and the panel cut-out. To achieve an IP66 seal between the instrument enclosure and the panel, the smaller cut-out must be used and the instrument secured with four panel mounting clips.

The BA688C liquid crystal display has maximum contrast when viewed from directly ahead and slightly below the centre line of the instrument.

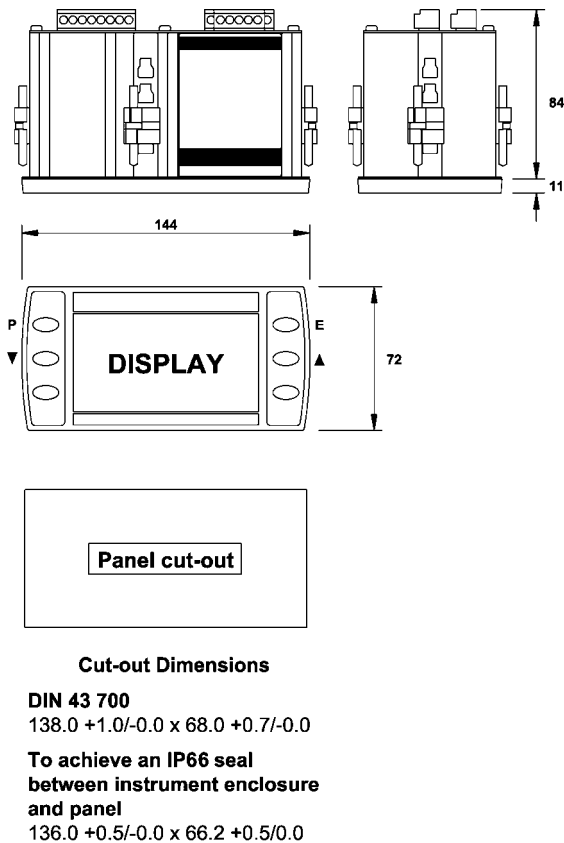
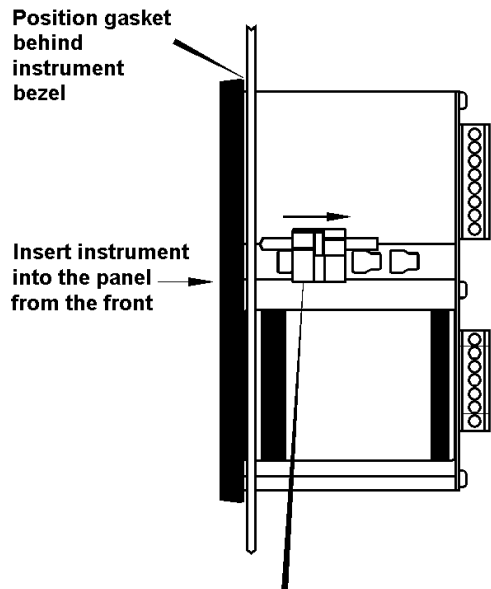

Fig 3 BA688C dimensions

5.2 Installation Procedure

- Insert the BA688C into the instrument panel cut-out from the front of the panel.
- Fix panel mounting clips to opposite sides of the instrument and tighten until the instrument is secure as shown in Fig 4. Four clips are required to achieve an IP66 seal between the instrument enclosure and the panel.
- Connect the panel wiring to the rear terminal block(s) as shown in Fig 4. To simplify installation, the terminals are removable so that panel wiring can be completed before the instrument is installed.



Slide panel mounting clip into the slotted rail on the side of the enclosure. Four clips are required to achieve an IP65 seal between instrument and panel.

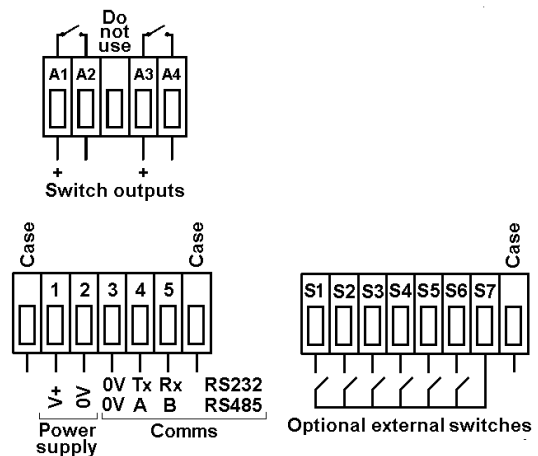

Fig 4 Installation and terminal connections

5.3 EMC

The BA688C complies with the requirements of the European EMC Directive 2008/108/EEC. For specified immunity all wiring should be in screened twisted pairs.

To prevent circulating currents, cable screens should only be earthed at one point.

6. CONFIGURATION

Before the BA688C can be commissioned it must be configured to be compatible with the host's communications format and have the required functions enabled.

The BA688C is configured via four of the front panel push-buttons. All the configuration functions are contained in an easy to use menu shown in Fig 5. Where necessary the sub-menus contain on-screen prompts to guide the user through each adjustment.

When navigating through the configuration menu, the push-button(s) should be held until the required screen is displayed.

6.1 Default configuration

Unless otherwise requested at time of ordering, BA688C text displays will be supplied configured as follows:

| | |
|------------------------------------|--------------|
| Baud rate | 9.6k |
| Data bits | 8 |
| Stop bit | 1 |
| Parity | None |
| Protocol | BEKA |
| Address | 0 |
| Operational mode | 1 |
| Keypad | Internal |
| Display brightness | 100% |
| Display contrast | 50% |
| Quick access menu | On |
| Show Status Text | On |
| Set Last Valid Input | 8 |
| Quick access menu code | 0000 |
| Configuration menu access code. | 0000 |
| Key mode | 0 |
| Screens | Text Display |

6.2 Accessing the configuration menus

Throughout this manual push-buttons are shown in italics e.g. *P* or *Up* push-button, and legends displayed by the instrument are shown within inverted commas e.g. 'Please enter code'.

The configuration menu is accessed by operating the *P* and *E* push-buttons simultaneously. Fig 3 shows the location of these push-buttons. If the BA688C is not protected by an access code the main menu will be displayed. If an access code other than the default code 0000 has already been entered, the BA688C will request that the access code be entered.

Using the *Up* or *Down* button set the first digit of the code which will be flashing. Pressing *P* will transfer control to the next digit which should be adjusted in the same way. When all four digits

have been set, pressing the *E* button will enter the access code. If the code is correct the main menu will be displayed, if the code is incorrect 'Invalid code' will be displayed.

When entering an access code, timeout will occur and the instrument will automatically return to the operating mode ten seconds after the push-buttons were last operated. In all other menus timeout occurs after thirty seconds.

When the main menu is displayed the required sub-menu can be highlighted by scrolling through the menu using the *Up* or *Down* push-button. Operating the *P* push-button will display the highlighted sub-menu from which a further selection may be made. After a configuration parameter has been adjusted, pressing the *E* button will enter the selection and move the display up one level.

After configuration has been completed, operating the *E* push-button repeatedly will return the instrument display to the main menu. One more operation of the *E* button will then return the BA688C to the operating mode.

6.3 Summary of configurable functions

This section provides a brief explanation of each configurable function and should be read in conjunction with Fig 5.

View settings

Displays the instruments main communication settings. Adjustments can not be made from this sub-menu.

Baud rate

Range depends upon type of port. For RS485, data rate may be set to one of ten speeds between 0.3 and 115.2kbaud. For RS232, data rate limited to one of seven rates between 0.3 and 19.2kbaud.

Data bits

7 or 8 data bits may be selected. 8 bit data is required in BEKA mode for graphics, for error checked modes and for Modbus.

Stop bits

1 or 2 stop bits may be selected.

Parity

An even, odd or no parity bit may be selected.

Protocol

BEKA, Legacy or Modbus protocol may be selected. The Legacy protocol is compatible with the MTL644.

Address

Each text display must be allocated a unique address within the following ranges:

| | | |
|-----------------|---------|--|
| Modbus protocol | 1 – 247 | } Zero reserved for single unit applications. |
| BEKA protocol | 0 – 247 | |
| Legacy protocol | 0 – 15 | |

Op Mode

Five different levels of communications security to be selected, ranging from immediate execution of a command with no acknowledgement, to a requirement for a 16 bit cyclic redundancy check. See the *Serial Text Display - Programming Guide* for a detailed explanation.

Not available with Legacy protocol.

Key mode

Key press data can be returned in three ways. See Response Format Section in the *Serial Text Display - Programming Guide*. Not applicable with Legacy protocol.

Keypad

This function allows the instrument front panel push-buttons or external push-buttons to be used for operator inputs. Whichever are selected, the instrument front panel push-buttons are used for configuration.

This function is not available when Legacy protocol is selected.

Settings

Allows the backlight brightness and contrast of the BA484D display to be adjusted.

Screens

One of nine standard screens or a custom screen may be selected.

Not applicable with Legacy protocol.

Quick access

This function enables the quick access menu described in section 7.4. When 'On' is selected an operator can adjust the screen brilliance and contrast without having access to other conditioning parameters.

Access code for the Quick Access Menu

'Access Code' in the display menu defines the four digit alphanumeric code that must be entered to gain access to the instrument's quick access menu. Alpha characters are case sensitive. Default code 0000 allows direct access without a code.

Status Text

The two single variable screens include a message 'Status: Good or Status: Bad', the Status Text function allows this message to be inhibited.

Last Valid Input

This function allows the number of process variables to be entered so that when scrolling the display unused screens are not shown.

Access code for the Configuration Menu

'Code' in the main menu defines the four digit alphanumeric code that must be entered to gain access to the instrument configuration menus. Alpha characters are case sensitive. Default code 0000 allows direct access without a code.

Unit information

Displays the instrument model number and the firmware version.

Configuration defaults

'Default' allows the configuration default defined in section 6.1 to be globally set.

6.4 Quick Access Menu

The quick access menu allows an operator to adjust the backlight brilliance and the display contrast without having access to the other configuration parameters.

The quick access menu is accessed by operating the *P* and *Up* push-buttons simultaneously. Fig 3 shows the location of these push-buttons. If the quick access menu is not protected by an access code the brilliance and contrast controls will be displayed immediately. If an access code other than the default code 0000 has already been entered, the BA688C will request that the access code be entered. Section 6.2 explains how an access code should be entered.

The backlight brilliance is adjusted using the *Up* and *Down* push-buttons. Operating the *P* push-button will transfer control to the display contrast adjustment. When both are set as required operating the *E* button will store both settings and return the instrument to the operating mode.

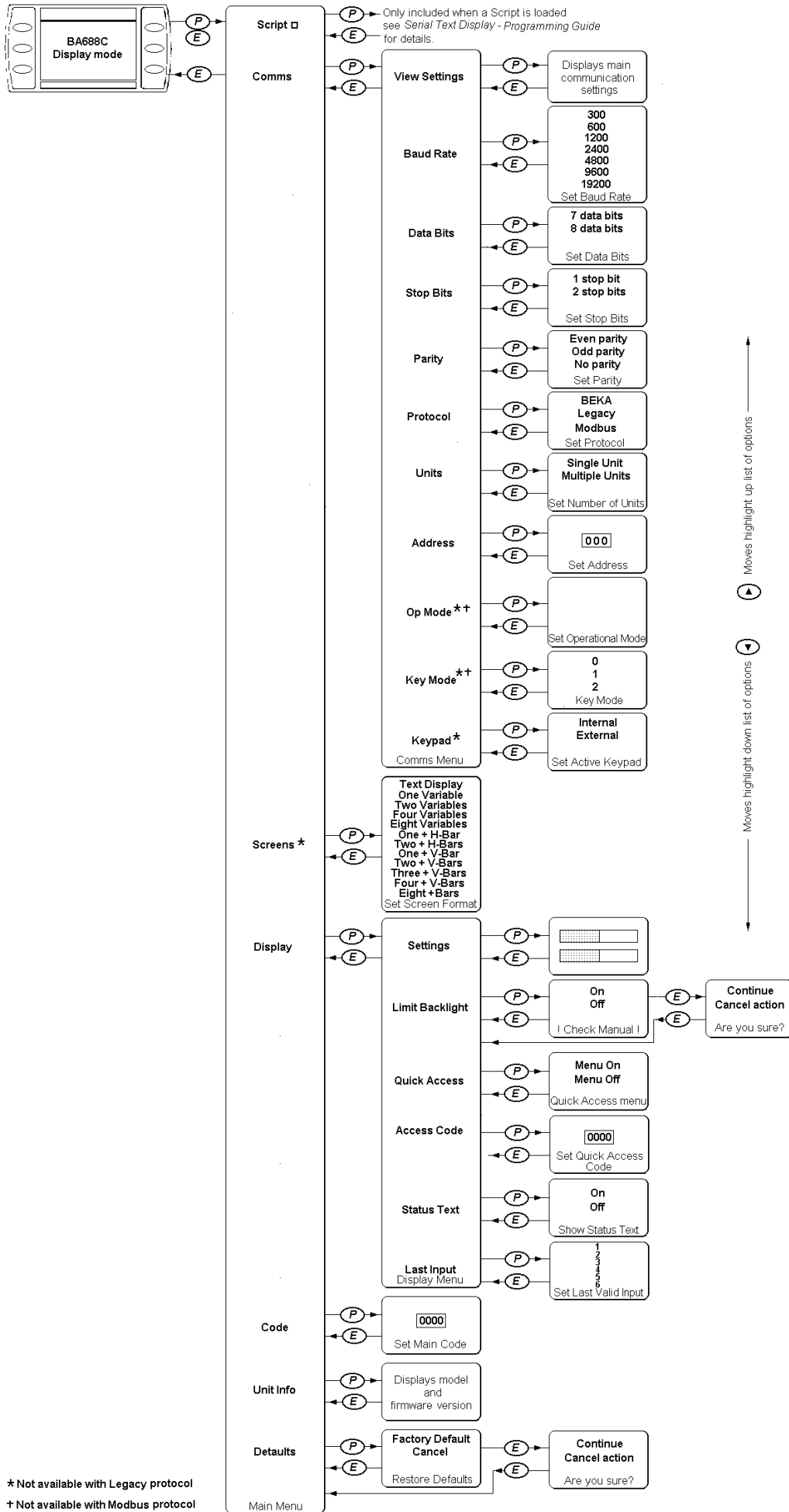

Fig 5 Structure of Configuration Menu

7. MAINTENANCE

7.1 Fault finding during commissioning

If a BA688C fails to function during commissioning the following procedure should be followed:

| Symptom | Cause | Check: |
|---------------------------------|--|---|
| No Display | No Power Incorrect wiring Earth fault | That there is 20 to 36 volts between terminal 1 and 2 of the seven way connector. Terminal 1 should be positive. That comms., signal & external switches are floating. |
| No Communication | Communications parameters incorrectly set | Input port, baud rate, data bits, stop bits and parity settings match those of the host. |
| | Incorrect Protocol | Protocol settings in "Comms" Menu |
| | Incorrect wiring | Wiring is as installation diagram |
| | Address incorrect | Address setting in "Comms" menu |
| Poor Communication | Communication cable too long. | Configuration settings. |
| | Communication speed too fast. | Installation guidelines |
| Dark Display | Contrast setting too high | Contrast level in "Display Settings" menu |
| Dim Backlight | Brilliance stting too low | Brightness level in "Display Settings" menu |
| Cannot enter configuration menu | Push-buttons not held for long enough (up to 2 seconds required) | Send "Configuration Enable" command (BEKA protocol) |
| | Menu inhibited | Restart unit (Legacy protocol) |

7.2 Fault finding after commissioning

ENSURE PLANT SAFETY BEFORE STARTING MAINTENANCE

If a BA688C fails after it has been functioning correctly, the table shown in section 7.1 may help to identify the cause of the failure.

If this procedure does not reveal the cause of the fault, please contact BEKA or our local agent.

7.3 Servicing

We recommend that faulty BA688C serial text displays are returned to BEKA associates or to our local agent for repair.

7.4 Routine maintenance

The mechanical and electrical condition of the instrument should be regularly checked. Initially annual inspections are recommended, but the inspection frequency should be adjusted to suit the environmental conditions.

7.5 Guarantee

Instruments which fail within the guarantee period should be returned to BEKA associates or our local agent. It is helpful if a brief description of the fault symptoms is provided.

7.6 Customer comments

BEKA associates is always pleased to receive comments from customers about our products and services. All communications are acknowledged and whenever possible, suggestions are implemented.

8. ACCESSORIES

8.1 Tag number

The BA688C can be supplied with a thermally printed tag number on the rear panel. This tag number is not visible from the front of the instrument after installation.

8.2 Serial Text Display - Programming Guide

A detailed guide to programming the BA688C serial text display using BEKA protocol may be requested from the BEKA sales office or downloaded from the BEKA website at www.beka.co.uk.

8.3 Serial Text Display – Modbus Guide

This guide explains how to use the BA688C serial text display as a slave in Modbus RTU systems. It may be requested from the BEKA sales office or downloaded from the BEKA website at www.beka.co.uk.

9. INDEX

| Subject | Section | Subject | Section |
|-------------------------|------------|-------------------|---------------|
| Address | 6. 6.3 | Maintenance | 7. |
| Access code | 6.3 | Routine | 7.4 |
| Backlight | 6. | Modbus | 3.2 |
| Baud rate | 6.3 | MTL644 display | 3.1 |
| BEKA protocol | 3.3 | Operational mode | 6.3 |
| Communication | 4.2 | Parity | 6.3 |
| speed | 6.3 | Power supply | 4.1 |
| Configuration | 6. | Protocol | 3, 6.3 |
| Access | 6.2 | Quick access menu | 6.3, 6.4 |
| Default settings | 6.1 | Access code | 6.3 |
| Structure | Fig 5 | RS232 port | 4.2 Fig 2 |
| Quick access menu | 6.4 | RS485 port | 4.2 Fig 2 |
| Data bits | 6.3 | Servicing | 7.3 |
| Display settings | 6.3 | Standard screens | 3.3 |
| EMC | 5.3 | Stop bits | 6.3 |
| External switches | 4.5 | Switch outputs | 4.3 |
| Fault finding | | Terminal numbers | Figs 1, 2 & 4 |
| During commissioning | 7.1 | Timeout | 6.2 |
| After commissioning | 7.2 | Unit information | 6.3 |
| Getting Started Quickly | Appendix 1 | View settings | 6.3 |
| Guarantee | 7.5 | | |
| Installation | 5.2 | | |
| Key mode | 6.3 | | |
| Keypad | 6.3 | | |
| Legacy protocol | 3.1 | | |
| Location | 5.1 | | |

APPENDIX 1

Getting Started Quickly

This appendix provides simple step-by-step instructions to get a BA688C Serial Text Display functioning quickly.

Communication

1. Connect dc power supply to the BA688C as shown in Fig 4.
2. Connect the serial communication port as shown in Fig 2 .
Note: The BA688C serial text display is available with either an RS232 or RS485 communication port. The port type is shown on a label adjacent to the port terminals.
3. Apply power.
4. The BA688C will display the model number, type of communication port and firmware details for a few seconds before reverting to the BEKA logo.
5. To set the instrument's basic communications parameters enter the configuration menu by pressing the *P* and *E* push-buttons simultaneously. Fig 5 shows the menu structure and navigation.
 The *P* button enters a menu, the *Up* and *Down* buttons select the required sub-menu or setting and the *E* button enters the selection and moves the display up one level.

The following menu items must be configured before use:

| Parameter | Select |
|-----------|--|
| Baud Rate | Comms. speed |
| Data Bits | 7 or 8 data bits |
| Stop Bits | 1 or 2 stop bits |
| Parity | Even, odd or none |
| Protocol | BEKA, Legacy or Modbus. |
| Address | Range depends on protocol: Modbus 1 to 247 BEKA 0 to 247 Legacy 0 to 15 |

The host and BA688C Serial Text Display should now be able to communicate.

Modbus protocol

Using Modbus RTU and one of the eleven standard screens is probably the easiest way to display process variables on a BA688C serial text display.

Select one of the standard screens shown in section 3.3 from the 'Screens' sub-menu.

Modbus register addresses for the instrument are shown in the *BEKA Serial Text Display – Modbus Interface Guide*, which is available from the BEKA sales office or from www.beka.co.uk

BEKA protocol

Please refer to the *BEKA Serial Text Display – Programming Guide* which is available from the BEKA sales office or from www.beka.co.uk

