

**Standard model**

81.. - ... - .

Compact pressure switch with CETOP connection flange 44 mm and steel piston for high pressure or elastomere diaphragm for pressures up to 40 bar, adjustable switch contact, housing aluminium, optionally in stainless steel (1.4301), optionally with ATEX **Ex ia** approval for GD

**Order code for standard units** (more versions upon request)

8	1	2	1	-	P	L	1	-	b	-	E	X	I
---	---	---	---	---	---	---	---	---	---	---	---	---	---

**Options**

E X I ATEX (EEx ia)

G L Germanischer Lloyd (shipbuilding)

U L Underwriter's Laboratories

**Sealing material**

b NBR nitrile-rubber

V FPM/FKM flour rubber

**Electrical connection**

P L 1 Cube plug DIN EN 175301-803 A (former DIN 43650)

P L 2 Plug M12x1 mm, 4-pin

**Microswitch contact**

1 Microswitch with silver contact

2 Microswitch with gold contact (e.g. used for PLC's)

**Pressure stages**

1	0.6... 6 bar	A	8... 85 psi
2	3.0... 20 bar	b	45... 250 psi
3	4.0... 45 bar	c	60... 650 psi
4	5.0... 180 bar	D	75... 2,600 psi
5	50.0... 350 bar	E	750... 5,000 psi
6	80.0... 600 bar	F	1,200... 8,700 psi

**Process connection**

1 CETOP - flange □ 40 x 40 mm

Fig. 10: Order code

**Operating Instructions**  
**Compact Pressure Switches Type Series 8000**

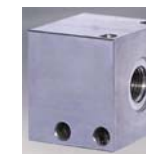

1	Intended Applications .....	2
2	Safety Instructions .....	2
3	Standards .....	3
4	Warranty/Guaranty .....	3
5	Transport/Storage .....	3
6	Installation/Commissioning .....	4
7	Maintenance/Cleaning .....	7
8	Technical Data .....	8

**Barksdale**  
CONTROL PRODUCTS

**Barksdale GmbH**  
Dorn-Assenheimer Straße 27  
D-61203 Reichelsheim

Phone: +49 (6035) 949-0  
Fax: +49 (6035) 949-111 and 949-113  
email: info@barksdale.de  
Internet: www.barksdale.de

Art. No.: 923-1302  
Index N, 24.05.2012



Specifications are subject to changes without notice!

## 1 Intended Applications

The pressure switches are specifically applied for monitoring and controlling of operations using maximum and minimum pressures. A micro switch triggers an electrical signal when minimum or maximum pressure are reached.

### DANGER

The switch may only be used in the specified fields of application (see type plate).  
The temperature has to be within the specified ranges, the pressure values and the electrical rating must not exceed the values specified.  
Observe also the applicable national safety instructions for assembly, commissioning and operation of the switch.  
The switch is not designed to be used as the only safety relevant element in pressurized systems according to DGR 97/23/EC.

## 2 Safety Instructions

The safety instructions are intended to protect the user from dangerous situations and/or material damage.

In the operating instructions the seriousness of the potential risk is designated by the following signal words:

### DANGER

Refers to imminent danger to men.  
Nonobservance may result in fatal injuries.

### WARNING

Refers to a recognizable danger.  
Nonobservance may result in fatal injuries, and destroy the equipment or plant parts.

### CAUTION

Refers to a danger.  
Nonobservance may result in light injuries and material damage to the equipment and/or to the plant.

### IMPORTANT

Refers to important information essential to the user.

### Disposal

The equipment must be disposed of correctly in accordance with the local regulations for electric/electronic equipment.  
The equipment must not be disposed of with the household garbage!

## 3 Standards

The standards applied during development, manufacture and configuration are listed in the CE conformity and manufacturer's declaration.

## 4 Warranty/Guaranty

### Warranty

Our scope of delivery and services is governed by the legal warranties and warranty periods.

### Terms of guaranty

We guaranty for function and material of the single- / dual- pressure switch under normal operating and maintenance conditions in accordance with the statutory provisions.

### Loss of guaranty

The agreed guaranty period will expire in case of:

- changes or modifications to the switch/housing/fitting
- incorrect use,
- incorrect installation or
- incorrect handling or operation contrary to the provisions of these operating instructions.

No liability is assumed for any damage resulting therefrom, or any consequential damage.

## 5 Transport/Storage

### CAUTION

Severe shock and vibrations should be avoided during transport. Storage should be dry and clean.

## 6 Installation/Commissioning

 <b>DANGER</b>
<p>Only install or uninstall the switch when deenergized (electrically and hydraulically/pneumatically). Pressure connection and electrical connection must be carried out by trained or instructed personnel according to state-of-the-art standards.</p> <p>The switch must only be installed in systems where the maximum pressure <math>P_{max}</math> is not exceeded (see type label).</p>

 <b>WARNING</b>
<p>Pressure peaks and pressure shocks exceeding the maximum operating pressure are inadmissible.</p> <p>The maximum operating pressure is the upper final value of the adjustable range or, if specified, the pressure indicated as maximum operating pressure. Exceeding the max. operating pressure affects the performance and the life span of the product and may damage it.</p> <p>Pressure switches must be mounted vibrationless.</p>

 <b>WARNING</b>
<p>Check the switch regularly for functioning.</p> <p>If the switch does not work properly, stop operation immediately!</p>

 <b>IMPORTANT</b>
<p>The standard flange version (CETOP) can be mounted directly on the hydraulic blocks. For pipe connection mounting blocks (see Fig. 9) with two or four bores are available for wall mounting (<math>\varnothing 5.6</math> mm).</p>

 <b>IMPORTANT</b>
<p>All pressure switches are tested for proper functioning before they leave the factory. The factory proof pressures are stated on the type plate.</p>

### Contact Protection

The micro switches used are normally suitable for both direct and alternating current operation. Inductive, capacitive and lamp loads may, however, considerably reduce the life expectancy of a micro switch and, under extreme circumstances, even damage the contacts.

Depending on the application spark suppression and current limiting is recommended (see succeeding figures).

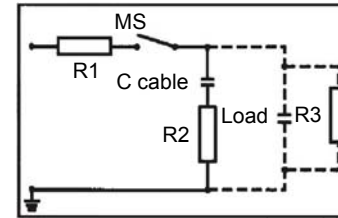

Fig. 1: Protection in case of capacitive loads  
R1: Protection against starting current rushes R2,R3: Protection against high discharge currents

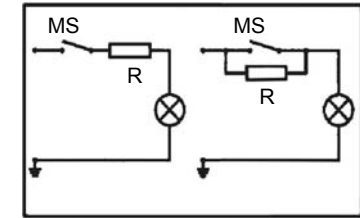

Fig. 2: Lamp load provided with resistance in parallel or series connection to switch of condensators

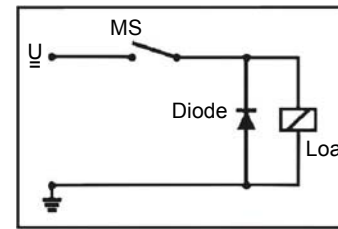

Fig. 3: Protection in case of continuous current and inductive load by recovery diode

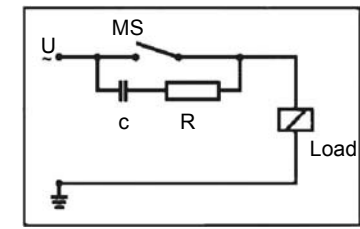



Fig. 4: Protection in case of alternating current and inductive load by RC-link

### Set point adjustment

 <b>IMPORTANT</b>
<p>Factory-Provided: pressure (temperature) switch point setting We confirm for pressure (temperature) switches that have been factory set the setting will be detailed on the label name plate.</p> <p>Warranty is not applicable for any changes that may occur due to transportation or installation. For critical applications we recommend the setting is checked and re-set if necessary after installation and wiring of the pressure (temperature) switch.</p>

In pressure switches, a displacement of the pressure sensing element occurs with a change in pressure. Following the displacement of the pressure sensing element operates a microswitch. Upon delivery of the product, the set points are likely to be found in the middle of the adjustable range. On request, fix set points may be adjusted by our factory. In this event, the point will be indicated on the type plate or any separate plate, i = increasing, d = decreasing.

The set point is adjusted by turning the captive adjustment screw (see Fig. 8).

Allow pressure switch to reach the desired switch pressure.

Turn adjustment screw clockwise or counterclockwise to actuate the micro switch.

	<b>IMPORTANT</b>
Please consult the wiring diagram for the contact status at atmospheric pressure (see Fig. 6).	

**Precise adjustment of set point to actuate on increasing pressure**

Lower system pressure to 0 bar.

Increase pressure slowly and check if micro switch is actuated at desired switch pressure.

If necessary, readjust by turning the adjustment screw

Repeat preceding steps until microswitch operates at desired switch pressure.

**Precise adjustment of set point to actuate on decreasing pressure**

Increase pressure up to a point clearly above the desired switch pressure (at least, switch pressure plus max. hysteresis; not above max. operating pressure).

Lower pressure slowly and check if micro switch is actuated at desired switch pressure.

If necessary, readjust by turning the adjustment screw

Repeat preceding steps until microswitch operates at desired switch pressure.

Following the adjustment of all set points, each set point must be checked and, if necessary, be readjusted.

**Electrical connections**, dimensions in mm (inch)

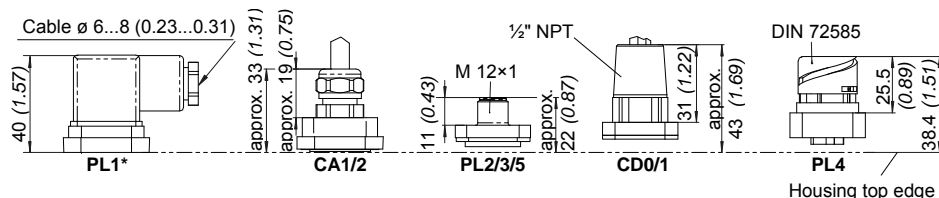

Fig. 5: \* Standard: PL1, all others optional – only on request

**Wiring code (contact status at atmospheric pressure)**





	PL 1	PL 2/3	PL 4	PL 5	CA 1/2			CD 0	CD 1
					old	new	no.		
	1	1	1	1	BN		1	VT	VT
	2	2	2	2	BK		2	BU	BU
	3	4	3	4	BU	GY	3	RD	RD
	---	3	---	---	GN/YE		GN/YE	---	GN

Fig. 6: Wiring Code

**Use in Hazardous Locations**

The pressure switches type Series 8000 with optional **Ex i** are approved for applications in hazardous locations for intrinsically safe circuits. Units designed for intrinsically safe **Ex i** application must be operated with a switch amplifier (see Fig. 7).

They are only for use in an approved intrinsically safe circuit.

Units with explosion-proof enclosures must be operated in accordance with their approval.

Approval class and identification characteristics according to type plate information must always be observed. The models having light-alloy (aluminium) enclosures or enclosure parts must be protected against all impact or friction which can ignite the explosive atmosphere. EC-design approved types are marked with a label according to ATEX 94/9/EC.

The wiring between switch and **Ex i** isolation amplifier must meet the local safety requirements.

The customer must provide for a highly conductive connection between switch and grounding.

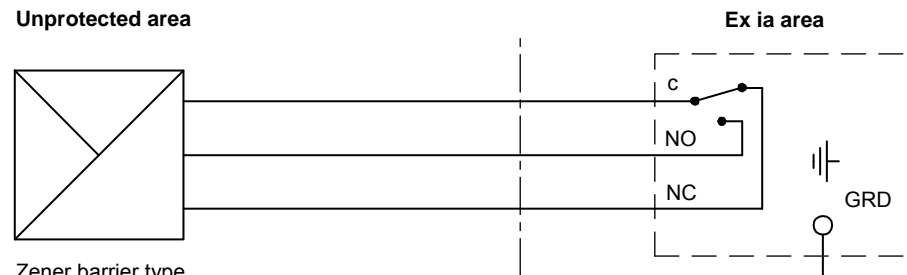

Zener barrier type  
Switch amplifier NAMUR

Fig. 7: Operation of pressure switches in intrinsically safe areas

**7 Maintenance/Cleaning**

**Maintenance**

The pressure switch is maintenance free. Checking the set points lies within the discretion of the user. The usual preventive maintenance work in accordance with the PED and ATEX guidelines must always be carried out.

Please note that small setpoint drifts may occur during the initial use of the switch (run-in period). To minimize the setpoint drift we can perform a run-in (ageing) process in our works on request. Larger or continuing setpoint drifts during the normal use of the switch may indicate that the measuring system is not used correctly within the specified limits, exceeding the design criteria or is worn-out. This might lead to metal fatigue of the measuring system and it therefore should be replaced before an ultimate rupture of the metal diaphragm might take place. Please consult your supplier or Barksdale directly for guidelines.

## 8 Technical Data

See data sheet

Dimensions in mm (inch)

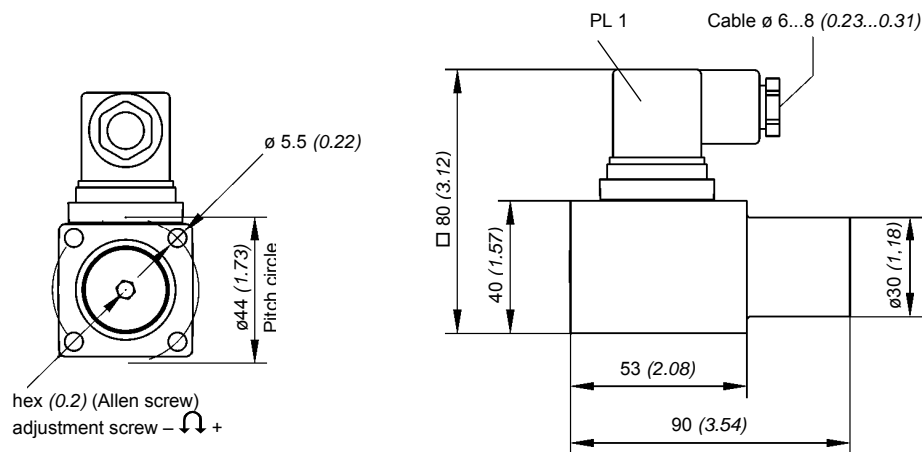

Fig. 8: Compact pressure switch type Series 8000, standard model

### IMPORTANT

4 x  $\varnothing 5.5$  mm (pitch circle  $\varnothing 44$  mm) for alternative mounting with screw M5x60 DIN 912 pressure range 6 (F) (up to 600 bar) must be mounted with four screws.

All lower pressure ranges can be mounted with two screws in diagonal order. Sufficient screws and the electrical plug PL1 are included in the delivery.

Torque to tighten the process connection to the pressure switch: 4...5 Nm.

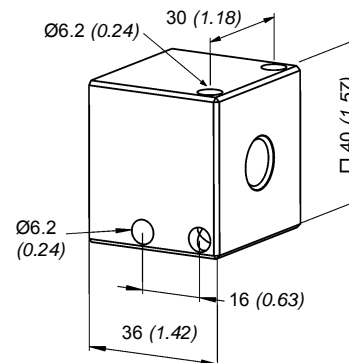
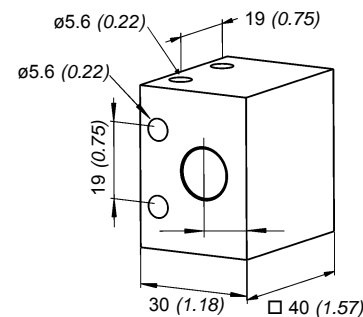
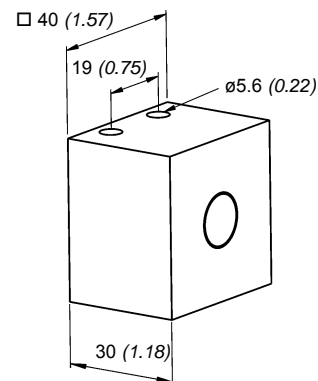

Fig. 9: Adaptors for compact pressure switch type Series 8000

Order No.	Process Connection	Material
906-0946	1/4" NPT female	1.4305
906-0947	G 1/4" female	1.4305
906-0953	1/4" NPT female	St passivated
906-0954	G 1/4" female	St passivated

Adaptor ①, straight

Order No.	Process Connection	Material
906-0046	CETOP	AlMg4,5Mn0,7
906-0946	1/4" NPT female	1.4305
906-0947	G 1/4" female	1.4305

Terminal block, version ②, 90° offset (optional, only upon request)

Order No.	Process Connection	Material
906-0919	G 1/4" female	AlMg4,5Mn0,7

Terminal block ③, compatible with X1T, 96100/96111 (optional, only upon request)

**Adjustable ranges**

Pressure range		Adjustable ranges (decreasing pressure)		Adjustable ranges (increasing pressure)		Max. operating pressure		Max. hysteresis (end of range)	Proof Press.	
[bar]	(psi)	[bar]	(psi)	[bar]	(psi)	[bar]	(psi)		[bar]	(psi)
<b>Diaphragm</b>										
1	A	0.4...5.7	(5.8...82)	0.6... 6.0	(8.7...87)	50	725	≤15 %	80 *	(1200)
2	B	2.0...17.0	(29.0...246)	3.0...20.0	(45.0...250)	50	725		80 *	(1200)
3	C	3.0...41.0	(43.0... 600)	4.0...45.0	(60.0...650)	50	725		80 *	(1200)
<b>Piston</b>										
4	D	3 ...160	(43...2320)	5...180	(75... 2600)	250	3600	≤15 %	600	(8700)
5	E	30...300	(430...4300)	50...350	(750...5000)	450	6500		600	(8700)
6	F	55...520	(800...7550)	80...600	(1200...8700)	600	8700		900	(15000)

\* Test pressure 200 bar (2900 psi) upon request, results in less lifetime of the switch.

**Electrical Ratings Silver Contacts**

Silver contacts	Inductive load	Resistive load
30 V =	2.0 A	5.0 A
250 V =	0.03 A	0.2 A
250 V~	2.0 A	5.0 A
125 V~	2.0 A	5.0 A
Minimum load values: 10 mA at 12 V DC		

 **IMPORTANT**

We recommend to use a prefuse of the maximum current rating from the table above according to the load switched.

**Electrical Ratings Gold Plated Contacts**

Gold plated contacts	Res. Load	Intrinsically safe circuits
≤ 300 mV DC	≤ 400 mA	U <sub>max</sub> 28 V=
≤ 30 V DC	≤ 4 mA	I <sub>max</sub> 50 mA
U x I = max 0.12 VA		
Minimum load values: 0 mA / 0 V DC		

 **IMPORTANT**

We recommend to use a prefuse of the maximum current rating from the table above according to the load switched.

We recommend gold plated contacts for all intrinsically safe and other applications with low voltage/power.

**Approval data for pressure switches type Series 8000 with PL1, PL4 connection**

Approval:  II 1 G D Ex ia IIB T6  
Ex ia D 20 T100

Certificate no.: ISSeP08ATEX016X

Permissible ambient temperature: -40 °C ... +75 °C

Electrical data for intrinsically safe application: U<sub>i</sub> = 28V li = 50 mA  
Ci = 40 pF Li = 4 μH

Standards applied: IEC 60079-0, IEC 60079-11, IEC 60079-26, IEC 61241-0 and IEC 61241-11

**Approval data for pressure switch type Series 8000 with PL2, PL3, CA, CD1 connection**

Approval:  II 1 G D Ex ia IIC T6  
Ex ia D 20 T100

Certificate no.: ISSeP08ATEX016X

Permissible ambient temperature: -40 °C ... +75 °C

Electrical data for intrinsically safe application: U<sub>i</sub> = 28V li = 50 mA  
Ci = 40 pF Li = 4 μH

Standards applied: IEC 60079-0, IEC 60079-11, IEC 60079-26, IEC 61241-0 and IEC 61241-11

**UL listed**

cULus,  
Type 4, file No. E42816

**Operating life time**

Normal expected service life (expressed in the number of cycles over the full adjustment range) is appr. 1 million for the pressure switch. This may be extended to 2.5 million cycles max. if only a part of the adjustment range is used (about 20%).

Switch sensor life may also be effected negatively by:

- Media not compatible with the wetted materials.
- Rapid pressure changes in the system, or in case of diaphragm switches >30 cycles/minute, in case of piston switches >60 cycles/minute.
- System cycling pressure exceeding the top of the adjustable range.

The proof pressure must never be exceeded, otherwise the switch may be damaged. Careful selection of the pressure range can have a positive effect on the service life of the switch.