



# XMP i

## Precision Pressure Transmitter for the Process Industry with HART®-Communication

Stainless Steel Sensor

accuracy according to IEC 60770:  
0.1 % FSO

### Nominal pressure

from 0 ... 400 mbar up to 0 ... 600 bar

### Output signals

2-wire: 4 ... 20 mA  
others on request

### Special characteristics

- ▶ turn-down 1:10
- ▶ two chamber aluminium die cast case or stainless field housing
- ▶ internal or flush welded diaphragm
- ▶ HART®-communication
- ▶ IS-version: Ex ia = intrinsically safe for gases and dusts





### Optional versions

- ▶ IS-version: Ex d = flameproof enclosure
- ▶ integrated display and operating module
- ▶ special materials as Hastelloy® and Tantalum
- ▶ cooling element for media temperatures up to 300 °C

The process pressure transmitter XMP i has been especially designed for the process industry and measures vacuum, gauge and absolute pressure ranges of gases, steam, fluids up to 600 bar.

Different process connections such as threads and flanges with an internal or flush welded diaphragm are available and can be combined with a cooling element for media temperatures up to 300°C. The transmitter is as a standard equipped with HART®-communication; the customer can choose between a two chamber aluminum die cast case or a stainless field housing.

### Preferred areas of use are

-  Oil and gas industry
-  Chemical and petrochemical industry
-  Energy Industry
-  Heavy Industry



Pressure ranges <sup>1</sup>												
Nominal pressure gauge / abs. <sup>2</sup>	[bar]	0.4	1	2	4	10	20	40	100	200	400	600
Overpressure	[bar]	2	5	10	20	40	80	105	210	600	1000	1000
Burst pressure ≥	[bar]	3	7,5	15	25	50	120	210	420	1000	1250	1250

<sup>1</sup> On customer request we adjust the devices within the turn-down-possibility by software to the required pressure ranges.  
<sup>2</sup> absolute pressure possible from 1 bar

Vacuum ranges						
Nominal pressure gauge	[bar]	-0.4 ... 0.4	-1 ... 1	-1 ... 2	-1 ... 4	-1 ... 10
Overpressure	[bar]	2	5	10	20	40
Burst pressure ≥	[bar]	3	7,5	15	25	50

Output signal / Supply	
Standard	2-wire: 4 ... 20 mA IS-intrinsically safe version with HART®-communication / V <sub>S</sub> = 12 ... 28 V <sub>DC</sub>
Option	IS version flameproof enclosure / V <sub>S</sub> = 13 ... 28 V <sub>DC</sub>
Current consumption	max. 25 mA
Performance	
Accuracy <sup>3</sup>	≤ ± 0.1 % FSO
Performance after turn-down	- turn-down ≤ 1:5: no change - turn-down > 1:5: The accuracy is calculated as follows ≤ 0.1 + 0.015 x (turn-down - 5) % FSO e.g. turn-down 9: ≤ 0.1 + 0.015 x (9 - 5) % FSO = 0.16 % FSO
Permissible load	R <sub>max</sub> = [(V <sub>S</sub> - V <sub>S min</sub> ) / 0.02 A] Ω      load during HART® communication: R <sub>min</sub> = 250 Ω
Influence effects	supply: 0.05 % FSO / 10 V      permissible load: 0.05 % FSO / kΩ
Long term stability	≤ ± 0.1 % FSO / year at reference conditions
Response time	100 msec – without consideration of electronic damping      measuring rate 10/sec
Adjustability	electronic damping: 0 ... 100 sec      offset 0 ... 90 % FSO;      turn-down of span up to 1:10

<sup>3</sup> accuracy according to IEC 60770 – limit point adjustment (non-linearity, hysteresis, repeatability)

Thermal errors / Permissible temperatures	
Tolerance band <sup>4,5</sup>	≤ 0.2 % FSO x turn-down (in compensated range -20 ... 85 °C)
Permissible temperatures <sup>6</sup>	medium: -40 ... 125 °C for filling fluid silicon oil -10 ... 125 °C for filling fluid food compatible oil without display: environment: -40 ... 80 °C storage: -40 ... 80 °C with display: environment: -20 ... 70 °C storage: -30 ... 80 °C
Permissible temperature medium for cooling element 300°C	filling fluid silicon oil      overpressure: -40 ... 300 °C      low pressure: -40 ... 150 °C filling fluid food compatible oil      overpressure: -10 ... 250 °C      low pressure: -10 ... 150 °C

<sup>4</sup> an optional cooling element can influence thermal effects for offset and span depending on installation position and filling conditions  
<sup>5</sup> for flange- and DRD-version: tolerance band offset ≤ ± 1.6 % FSO / tolerance band span ≤ ± 0.6 % FSO  
<sup>6</sup> max. temperature of the medium for nominal pressure gauge > 0 bar: 150 °C for 60 minutes with a max. environmental temperature of 50 °C (without cooling element).

Electrical protection	
Short-circuit protection	permanent
Reverse polarity protection	no damage, but also no function
Electromagnetic compatibility	emission and immunity according to EN 61326

Mechanical stability	
Vibration	5 g RMS (25 ... 2000 Hz)      according to DIN EN 60068-2-6
Shock	100 g / 11 msec      according to DIN EN 60068-2-27

Filling fluids	
Standard	silicon oil
Options for process connections	food compatible oil (with FDA approval) (Mobil SHC Cibus 32; Category Code: H1; NSF Registration No.: 141500) Halocarbon and others on request

Materials	
Pressure port	stainless steel 1.4404 (316L)
Housing	aluminium die cast, powder-coated or stainless steel 1.4404 (316L)
Cable gland	brass, nickel plated
Viewing glass	laminated safety glass
Seals (media wetted)	thread:      standard: FKM option: FFKM (min. permissible temperature from -15 °C, possible for nominal pressure ranges P <sub>N</sub> ≤ 100 bar); others on request option: welded version for pressure ports according to EN 837 with P <sub>N</sub> between 1 and 40 bar DRD and flange: none, not included in the scope of delivery
Diaphragm Standard	stainless steel 1.4435 (316 L)
Options for process connections	Hastelloy® C-276 (2.4819), Tantalum (possible from 1 bar) on request
Media wetted parts	pressure port, seal, diaphragm

<b>Explosion protection</b>	
Approval AX12-XMP i	IBExU 05 ATEX 1106 X stainless steel field housing: zone 0 / 20: II 1G Ex ia IIC T4 Ga / II 1D Ex ia IIIC T85 °C Da aluminium die cast case: zone 1 / 20: II 2G Ex ia IIB T4 Gb / II 1D Ex ia IIIC T85 °C Da
Safety technical maximum values	$U_i = 28\text{ V}$ , $I_i = 98\text{ mA}$ , $P_i = 680\text{ mW}$ , $C_i = 0\text{ nF}$ , $L_i = 0\text{ }\mu\text{H}$ , $C_{\text{GND}} = 27\text{ nF}$
Approval AX17-XMP i (flameproof enclosure)	IBExU 12 ATEX 1045 X aluminium die cast case: zone 1: II 2G Ex d IIC T5 Gb
Permissible temperatures for environment	in zone 0: -20 ... 60 °C with $p_{\text{atm}}$ 0.8 bar up to 1.1 bar zone 1 or higher: -25 ... 70 °C (intrinsically safe version); -20 ... 70 °C (flameproof enclosure)
Connecting cables (by factory)	capacitance: signal line/shield also signal line/signal line: 160 pF/m inductance: signal line/shield also signal line/signal line: 1 $\mu\text{H}/\text{m}$

<b>Miscellaneous</b>	
Display (optionally)	LC-display, visible range 32.5 x 22.5 mm; 5-digit 7-segment main display, digit height 8 mm, range of indication $\pm 9999$ ; 8-digit 14-segment additional display, digit height 5 mm; 52-segment bargraph; accuracy 0.1% $\pm$ 1 digit
Ingress protection	IP 67
Installation position	any (standard calibration in a vertical position with the pressure port connection down; differing installation position have to be specified in the order)
Weight	min. 400 g (depending on housing and mechanical connection)
Operational life	> 100 x 10 <sup>6</sup> pressure cycles
CE-conformity	EMC Directive: 2004/108/EC Pressure Equipment Directive: 97/23/EC (module A) <sup>7</sup>

<sup>7</sup> This directive is only valid for devices with maximum permissible overpressure > 200 bar

**Wiring diagram**

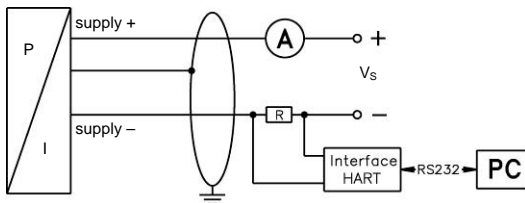

<b>Pin configuration</b>		
Electrical connections	<b>aluminium die cast case:</b> terminal clamps (clamp section: 2.5 mm <sup>2</sup> )	<b>stainless steel field housing:</b> terminal clamps (clamp section: 1.5 mm <sup>2</sup> )
Supply +	IN+	IN+
Supply -	IN-	IN-
Test	Test	-
Shield	$\perp$	$\perp$

**Housing designs<sup>8</sup> (dimensions in mm)**

**aluminium die cast case**

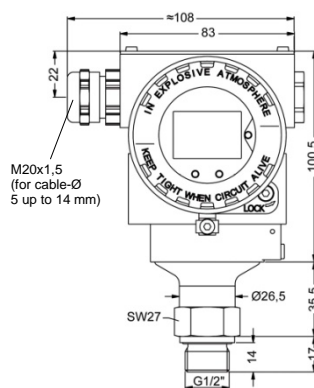
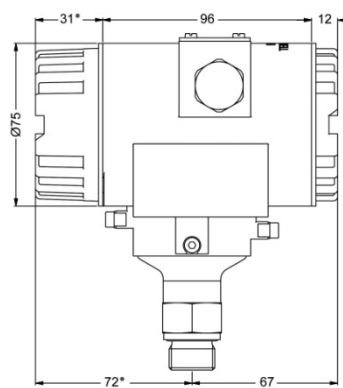

**stainless steel field housing**

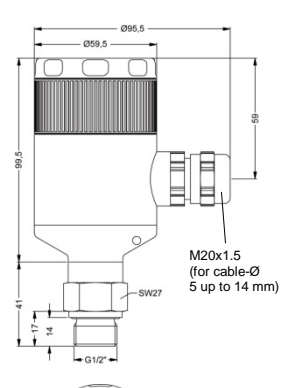
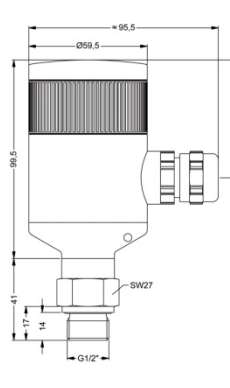

\* without display and operating module marked dimensions decrease by 19 mm (with aluminium case)

⇒ for nominal pressure  $P_N > 400\text{ bar}$  increases the length of devices by 39 mm

<sup>8</sup> aluminium case is horizontally rotatable as standard

**Standard pressure ports (dimensions in mm)**

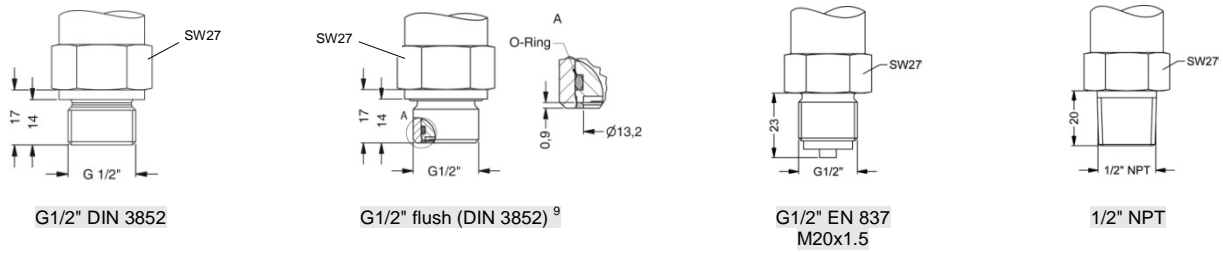

<sup>9</sup> not possible for vacuum and nominal pressure ranges > 40 bar

**Process connections up to 40 bar (dimensions in mm)**

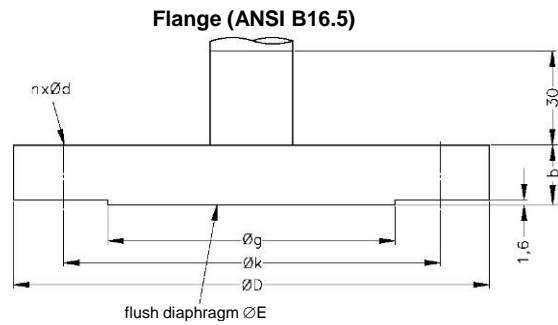
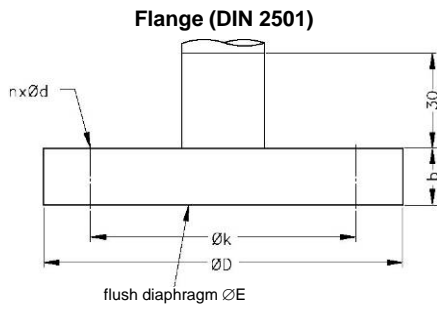
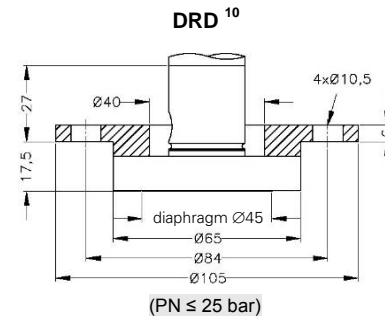
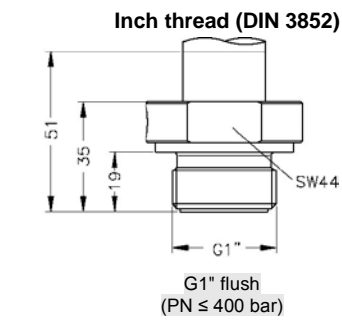

dimensions in mm			
size	DN25/PN40	DN50/PN40	DN80/PN16
D	115	165	200
E	30	89	89
k	85	125	160
b	18	20	20
n	4	4	8
d	14	18	18
PN	≤ 40 bar	≤ 40 bar	≤ 16 bar

dimensions in mm		
size	2"/150 lbs	3"/150 lbs
D	152.4	190.5
E	86	89
g	91.9	127
k	120.7	152.4
b	19.1	23.9
n	4	4
d	19.1	19.1
PN	≤ 10 bar	≤ 10 bar

**Cooling element**

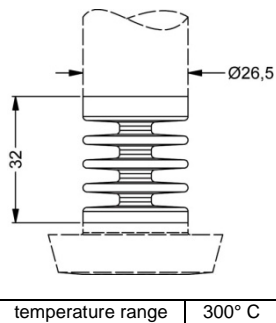

<sup>10</sup> mounting flange is included in the delivery (already pre-assembled)

HART® is a registered trade mark of HART Communication Foundation; Hastelloy® is a brand name of Haynes International Inc. Windows® is a registered trade mark of Microsoft Corporation

## Ordering code XMP i

XMP i

□□□□ - □□□□ - □□□ - □□ - □□ - □□□□ - □□□□ - □□ - □□ - □□□□

Pressure		5	1	1																											
	gauge	5	1	1																											
	absolute <sup>1</sup>	5	1	2																											
Input																															
	[bar]																														
	0 ... 0.4 <sup>1</sup>				4	0	0	0																							
	0 ... 1				1	0	0	1																							
	0 ... 2				2	0	0	1																							
	0 ... 4				4	0	0	1																							
	0 ... 10				1	0	0	2																							
	0 ... 20				2	0	0	2																							
	0 ... 40				4	0	0	2																							
	0 ... 100				1	0	0	3																							
	0 ... 200				2	0	0	3																							
	0 ... 400				4	0	0	3																							
	0 ... 600				6	0	0	3																							
	-0.4 ... 0.4				S	4	0	0																							
	-1 ... 1				S	1	0	2																							
	-1 ... 2				V	2	0	2																							
	-1 ... 4				V	4	0	2																							
	-1 ... 10				V	1	0	3																							
	customer				9	9	9	9													consult										
Design																															
<b>Aluminium die cast case</b>																															
	with display																				A	0									
	without display																					A	N								
<b>Stainless steel field housing</b>																															
	with display																					F	V								
	without display																						F	N							
	customer																						9	9							
																								consult							
Output																															
	Intrinsic safety 4 ... 20 mA / 2-wire with HART <sup>®</sup> -communication																							I							
	Intrinsic safety Ex d 4 ... 20 mA / 2-wire (flameproof enclosure) with HART <sup>®</sup> -communication <sup>2</sup>																							G							
	customer																							9							
																								consult							
Accuracy																															
	0.1 %																							1							
Electrical connection																															
	terminal clamp alu housing																							A	K	0					
	terminal clamp field housing																								8	8	0				
	customer																								9	9	9				
																											consult				
Mechanical connection																															
<i>Standard pressure connections</i>																															
	G1/2" DIN 3852																								1	0	0				
	G1/2" DIN 3852 with <sup>3</sup> flush sensor																									F	0	0			
	G1/2" EN 837																									2	0	0			
	1/2" NPT																									N	0	0			
<i>Process connections (up to 40 bar)</i>																															
	G1" with flush welded diaphragm (DIN 3852)																									Z	3	1			
	Flange DN 25 / PN 40 (DIN 2501)																										F	2	0		
	Flange DN 50 / PN 40 (DIN 2501)																										F	2	3		
	Flange DN 80 / PN 16 (DIN 2501)																										F	1	4		
	Flansch DN 2" / 150 lbs (ANSI B16.5) <sup>4</sup>																										F	3	2		
	Flansch DN 3" / 150 lbs (ANSI B16.5) <sup>4</sup>																										F	3	3		
	DRD Ø 65 mm <sup>5</sup>																										D	R	D		
Diaphragm																															
	Stainless steel 1.4435 (316L)																											1			
	Hastelloy <sup>®</sup> <sup>6</sup>																											H			
	Tantal <sup>6,7</sup>																											T			
																													consult		
Seals																															
<i>Inch thread:</i>																															
	FKM																												1		
	FFKM <sup>8</sup>																												7		
	EN 837: without (welded version) <sup>9</sup>																												2		
	DRD, flange: without																												0		
Filling Fluids																															
	Silicon oil																												1		
	food compatible oil <sup>6</sup>																												2		
	Halocarbon <sup>6</sup>																												C		
	customer																												9		
																													consult		
Special version																															
	standard																												0	0	0
	with cooling element up to 300 °C <sup>6</sup>																												2	0	0
	special compensation -40 ... +60 °C <sup>10</sup>																												0	2	2

⚠ if setting range shall be different from nominal range please specify in your order

- <sup>1</sup> absolute pressure possible from 1 bar
- <sup>2</sup> only possible in combination with aluminium die cast case
- <sup>3</sup> not possible for vacuum ranges and pressure ranges > 40 bar
- <sup>4</sup> 2"/150 lbs and 3"/150 lbs possible for nominal pressure ranges P<sub>N</sub> ≤ 10 bar
- <sup>5</sup> mounting flange is included in the delivery (already pre-assembled)
- <sup>6</sup> only possible with process connections
- <sup>7</sup> tantal diaphragm possible with nominal pressure ranges from 1 bar
- <sup>8</sup> min. permissible temperature from -15 °C, possible for nominal pressure ranges P<sub>N</sub> ≤ 100 bar
- <sup>9</sup> possible with pressure ranges between 1 bar and 40 bar
- <sup>10</sup> option for version without display

HART<sup>®</sup> is a registered trade mark of HART Communication Foundation; Hastelloy<sup>®</sup> is a brand name of Haynes International Inc.

01.06.2013

This document contains product specification; properties are not guaranteed. Detailed information about options are defined in the datasheet. Subject to change without notice.

